

## Omnipolar Hall Switch Sensor

XL561

### Features

- Wide Operating Voltage Range: 3.3V~45V
- Low Quiescent Current : 2.5mA
- Device HBM ESD Classification Level Class3B
- Reverse Supply Protection
- 50mA Load Capacity
- TO92S-3 package
- Magnetic Field Operate Point :  $\pm 7.5\text{mT}$
- Magnetic Field Release Point :  $\pm 3.5\text{mT}$

### Applications

- Power tools
- Flow sensors
- Valve and solenoid status
- Brushless DC motor position sensors
- Tachometers

### General Description

The XL561 is an omnipolar Hall switch sensor that optimized for wide voltage, low quiescent current and wide temperature range. XL561 supports a power supply voltage of up to  $\pm 50\text{V}$  and provide a load capacity of up to 50mA. Widely used in automotive electronics, industrial control and other applications. Adopting a collector open circuit output architecture, it has strong resistance to electromagnetic interference.

The XL561 integrates a reference voltage source, temperature compensation, Hall array, differential comparator, hysteresis latch, and power output stage, providing high magnetic field consistency, and strong immunity to electromagnetic interference over the full voltage range and full temperature range.

### Typical application schematic

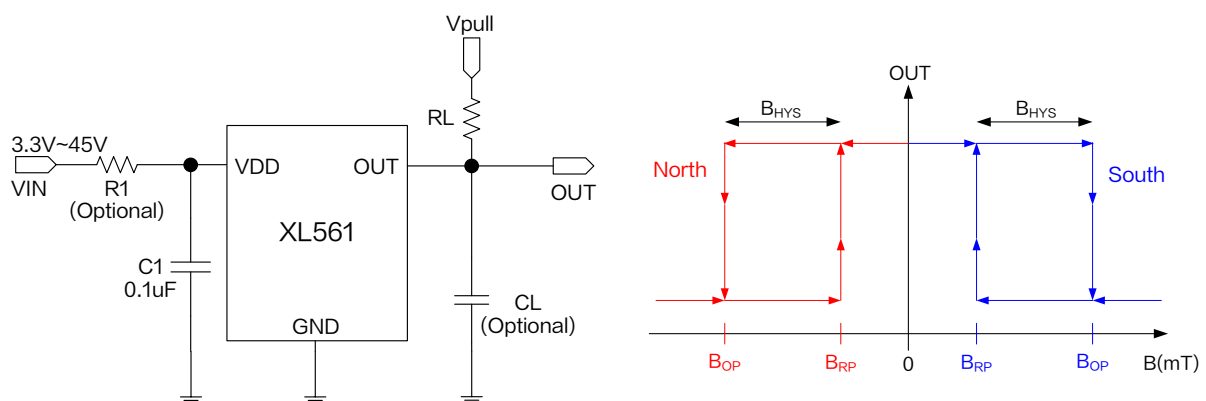

Figure1. XL561 Typical application schematic and output characteristic curve

Omnipolar Hall Switch Sensor

XL561

### Pin Configurations

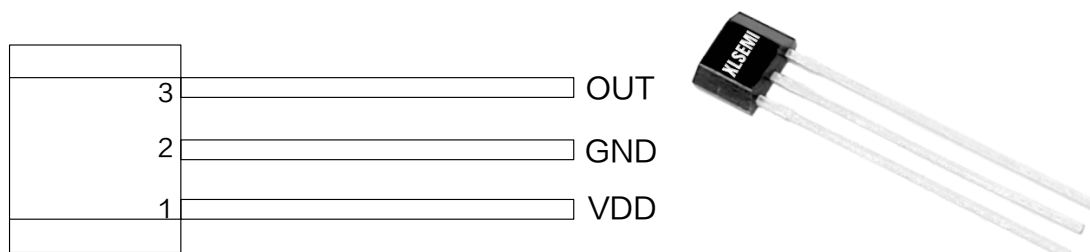

Figure2. Pin Configuration of XL561

Table 1 Pin Description

Pin Number	Pin Name	Description
1	VDD	Supply Voltage Input Pin. XL561 operates from 3.3V to 45V DC voltage.
2	GND	Ground pin.
3	OUT	Open Collector Output Pin, requires a resistor pull-up.

### Ordering Information

Order Information	Marking ID	Package Type	Eco Plan	Packing Type Supplied As
XL561	XL561	TO92S-3	RoHS & HF	10000 Units Per Box

Function Block

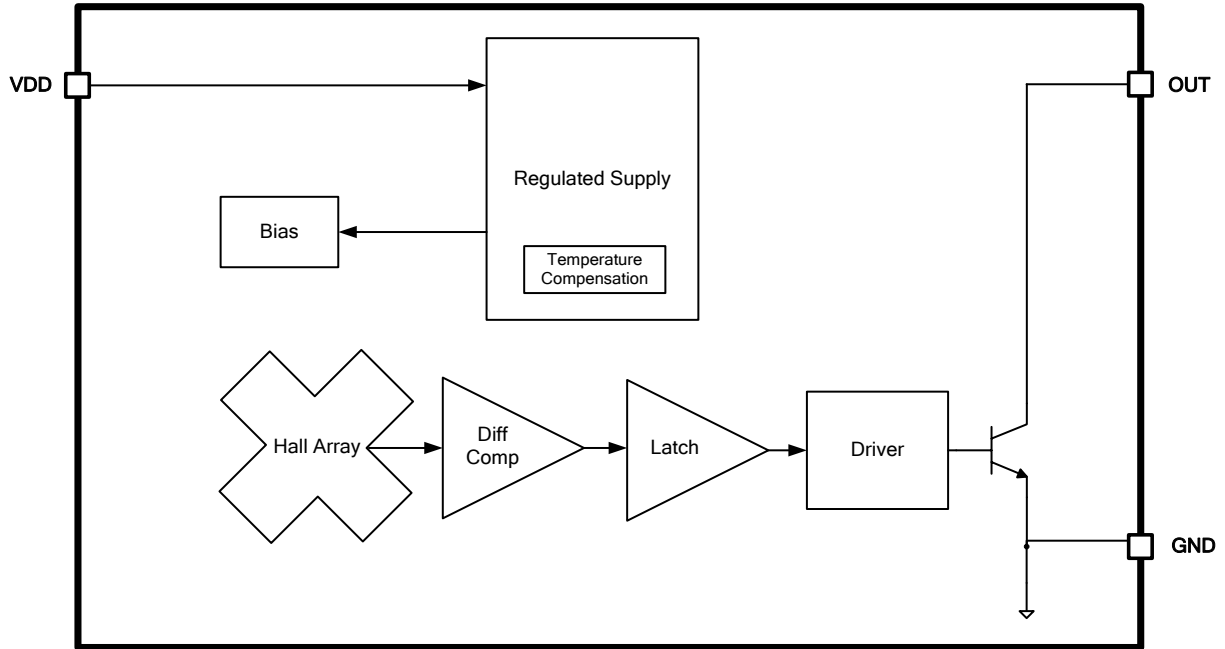

Figure3. Function Block Diagram of XL561

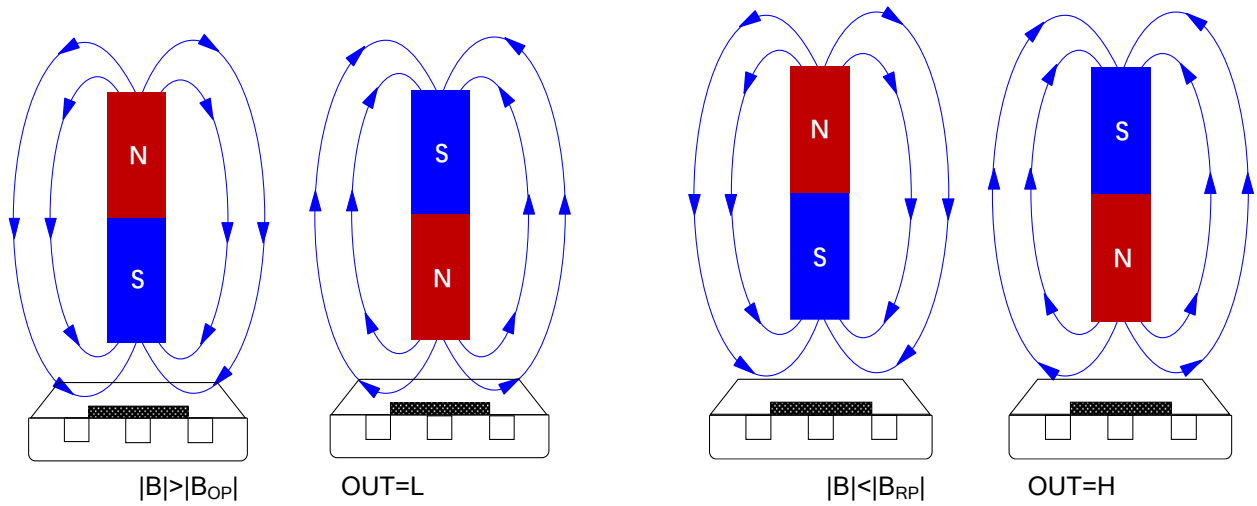

Figure4. Magnetic Field Direction Definition

Omnipolar Hall Switch Sensor

XL561

### Absolute Maximum Ratings ( Note1 )

Parameter	Symbol	Value	Unit
Input Voltage	$V_{DD}$	-50 ~ 50	V
Output Pin Voltage	$V_{OUT}$	-0.5 ~ 50	V
Output Pin Current Sink	$I_{SINK}$	0 ~ 50	mA
Thermal Resistance (TO92S-3) (Junction to Ambient, No Heatsink, Free Air)	$R_{JA}$	160	°C/W
Operating Temperature	$T_A$	-40 ~ 125	°C
Operating Junction Temperature	$T_J$	-40 ~ 150	°C
Storage Temperature	$T_{STG}$	-65 ~ 150	°C
Lead Temperature (Soldering, 10 sec)	$T_{LEAD}$	260	°C
ESD (HBM)		>8000	V

**Note1:** Stresses greater than those listed under Maximum Ratings may cause permanent damage to the device. This is a stress rating only and functional operation of the device at these or any other conditions above those indicated in the operation is not implied. Exposure to absolute maximum rating conditions for extended periods may affect reliability.

Omnipolar Hall Switch Sensor

XL561

## XL561 Electrical Characteristics

$T_A = 25^\circ\text{C}$ ,  $V_{DD} = V_{pull} = 5\text{V}$ ,  $R_L = 1\text{k}\Omega$ ,  $R_1 = 0\Omega$ ; system parameters test circuit figure1, unless otherwise specified.

Parameters	Symbol	Test Condition	Min.	Typ.	Max.	Unit
Operation Voltage	$V_{DD}$		3.3		45	V
Reverse Supply Voltage	$V_{DDR}$		-45			V
Operation Supply Current	$I_{DD\_H}$	OUT=H		2.5		mA
	$I_{DD\_L}$	OUT=L		3.2		mA
Power-on time	$t_{ON}$			35	50	$\mu\text{s}$
Output Saturation Voltage	$V_{sat}$	$I_{OUT} = 30\text{mA}$		0.2	0.3	V
Output Delay Time	$t_d$	$B = B_{RP}$ to $B_{OP}$		10	25	$\mu\text{s}$
Output Rise Time	$t_r$	$CL = 50\text{pF}$			0.5	$\mu\text{s}$
Output Fall Time	$t_f$	$CL = 50\text{pF}$			0.2	$\mu\text{s}$

## XL561 Magnetic Characteristics ( Note2 )

$T_A = 25^\circ\text{C}$ ,  $V_{DD} = V_{pull} = 5\text{V}$ ,  $R_L = 1\text{k}\Omega$ ,  $R_1 = 0\Omega$ ; system parameters test circuit figure1, unless otherwise specified.

Parameters	Symbol	Test Condition	Min.	Typ.	Max.	Unit
Bandwidth	$f_{BW}$				100	KHz
Magnetic Field Operate Point	$B_{OP}$		$\pm 5.0$	$\pm 7.5$	$\pm 13.0$	mT
Magnetic Field Release Point	$B_{RP}$		$\pm 1.5$	$\pm 3.5$	$\pm 8.0$	mT
Magnetic Hysteresis	$B_{HYS}$			$\pm 4.0$		mT

**Note2** : A south pole near the marked side of the package is a positive magnetic field.

## Typical Characteristics

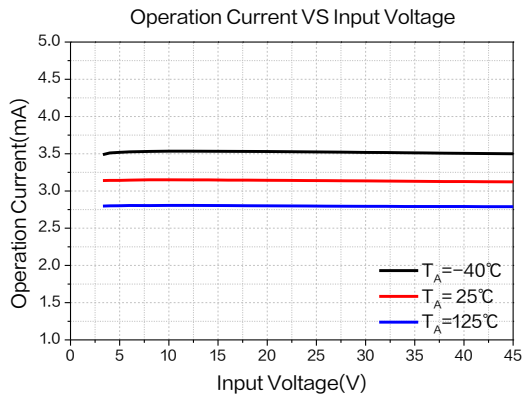

Figure 5. Operation Current

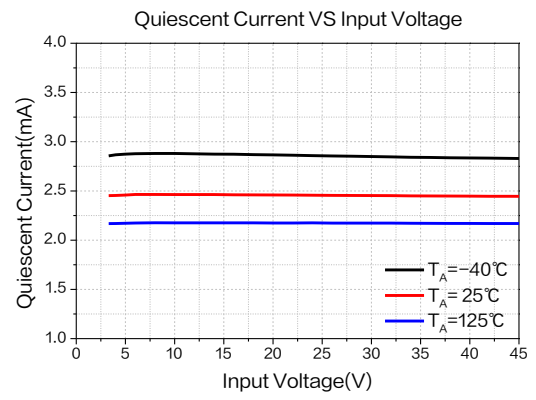

Figure 6. Quiescent Current

Omnipolar Hall Switch Sensor

XL561

### Package Information

TO92S-3

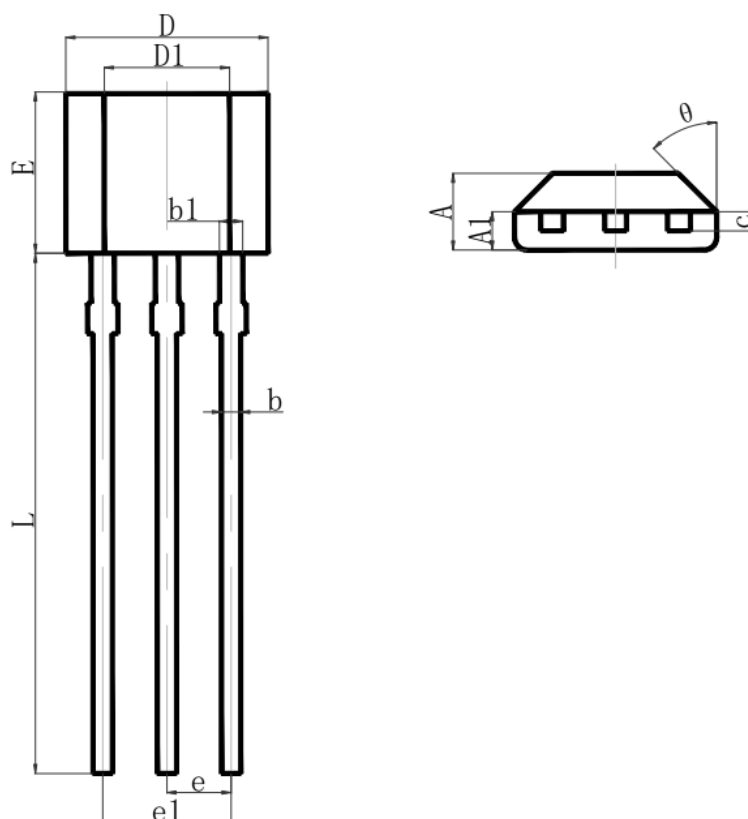

Symbol	Dimensions In Millimeters		Dimensions In Inches	
	Min.	Max.	Min.	Max.
A	1.42	1.62	0.056	0.064
A1	0.66	0.86	0.026	0.034
b	0.33	0.48	0.013	0.019
b1	0.40	0.51	0.016	0.020
c	0.33	0.51	0.013	0.020
D	3.90	4.10	0.154	0.161
D1	2.28	2.68	0.090	0.106
E	3.05	3.25	0.120	0.128
e	1.27 REF.		0.050 REF.	
e1	2.44	2.64	0.096	0.104
L	15.10	15.50	0.594	0.610
θ	45° REF.		45° REF.	

---

Omnipolar Hall Switch Sensor	XL561
------------------------------	-------

---

### Important Notice

XLSEMI reserve the right to make modifications, enhancements, improvements, corrections or other changes without notice at any time. XLSEMI does not assume any liability arising out of the application or use of any product described herein; neither does it convey any license under its patent rights, nor the rights of others. XLSEMI assumes no liability for applications assistance or the design of Buyers' products. Buyers are responsible for their products and applications using XLSEMI components. To minimize the risks associated with Buyers' products and applications, Buyers should provide adequate design and operating safeguards. XLSEMI warrants performance of its products to the specifications applicable at the time of sale, in accordance with the warranty in XLSEMI's terms and conditions of sale of semiconductor products. Testing and other quality control techniques are used to the extent XLSEMI deems necessary to support this warranty. Except where mandated by applicable law, testing of all parameters of each component is not necessarily performed.

For the latest product information, go to [www.xlsemi.com](http://www.xlsemi.com).